

◆Characteristics / 特點：

- Ultra slim body, 13mm thickness only.
/13mm超薄型，寬度僅有30mm。
- Min. Detectable Object Ø30mm.
/最小檢測物Ø30mm。
- Green and red LED blink in sequence from top to bottom under normal emission. All LED light up under the emitting circuit failure.
/未感應時，綠色與紅色LED依序閃爍，當有物體遮斷時，LED則全部一起亮。

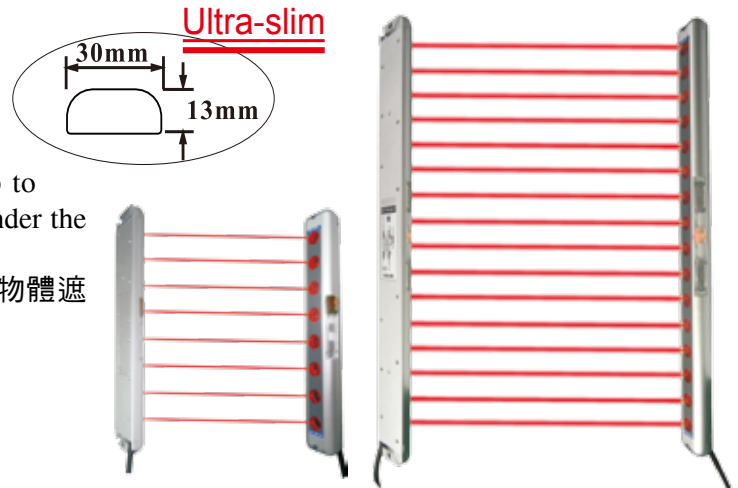

◆Specifications / 規格表：

Model / 型號	NPN D.on	OAP-2008-NK	OAP-2008S-NK	OAP-2016-NK	OAP-2016S-NK
	PNP D.on	OAP-2008-PK	OAP-2008S-PK	OAP-2016-PK	OAP-2016S-PK
Sensing type / 檢出方式	Through beam / 對照式				
Resolution / 分辨率	30 mm opaque object 不透明物體				
Sensing distance / 檢出距離	0.6 M ~ 5 M	0.3 M ~ 2 M	0.9 M ~ 5 M	0.5 M ~ 2 M	
Sensing Height / 檢測高度	140 mm		300 mm		
Emitting light / 發光源	Infrared LED(紅外線發光LED) : 850 nm				
No.of Beams/光軸數	8			16	
Beam pitch / 光軸間距	20 mm				
Indicating LED / LED指示燈	5 LEDs each on emitter and receiver.		7LEDs each on emitter and receiver.		
	LEDs blink from top to bottom under the normal emission. All LEDs light up under the emitting circuit failure and will become blinking until the normal emission.				
Running type / 運轉方式	More than a beam is covered ON (Dark On) 任意一個光束被遮斷即輸出				
Operating voltage / 工作電壓	DC12 ~ 24 V±10% (ripple P-P : 10% Max.)				
Current Consumption / 消耗電流	Transmitter : 90 mA Max.		Transmitter : 135 mA Max.		
	Receiver : 35 mA Max.		Receiver : 70 mA Max.		
Load current / 負載電流	100 mA Max at DC 24V				
Protection circuit / 保護電路	Reversed Supply circuit protection, Short circuit protection output 電源反接保護及輸出短路保護				
Response time / 反應時間	Off to On : 15 ms Max.				
	On to Off : 20 ms Max.				
Insulation resistance / 隔離阻抗	20MΩ min. (DC500V)				
Voltage withstandability / 絕緣耐壓	AC1000V 60Hz for 60 Sec.				
Operating temperature / 工作溫度	- 10 °C ~ + 45 °C (No freezing allowed不可結霜,結冰)				
Ambient humidity / 工作溼度	35% ~ 85% RH 相對溼度				
Storage temperature / 儲存時溫度	- 10 °C ~ + 45 °C (No freezing allowed不可結霜,結冰)				
Storage humidity / 儲存時溼度	35% ~ 95% RH 相對溼度				
Protection degree / 防水等級	IP62				
Material / 外觀材質	ABS				
Wiring method / 出線方式	Transmitter : M12 pigtailed type(5P) / M12接頭15cm電線式				
	Receiver : M12 pigtailed type(5P) / M12接頭15cm電線式				
Weight / 重量	Approx.200g			Approx.253g	

Photo Sensor

Area Sensor

Inductive Proximity Sensor

Capacitive Proximity Sensor

Timer / Counter

Others

Accessories

◆ Applications / 應用例 :

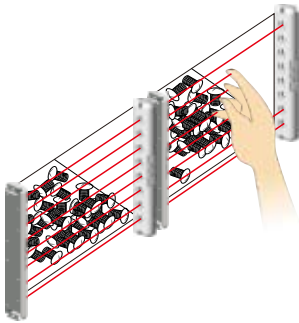

To prevent wrong access of parts-taking.
防止誤取發動機部件

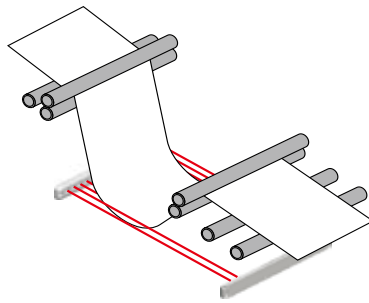

Detecting a reel.
檢查卷筒

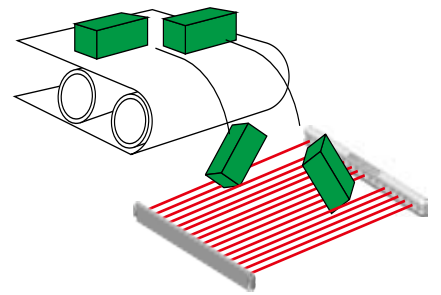

Detecting the falling objects in uncertain route.
檢查路徑不確定的下落物體

◆ Dimensions / 外型尺寸 :

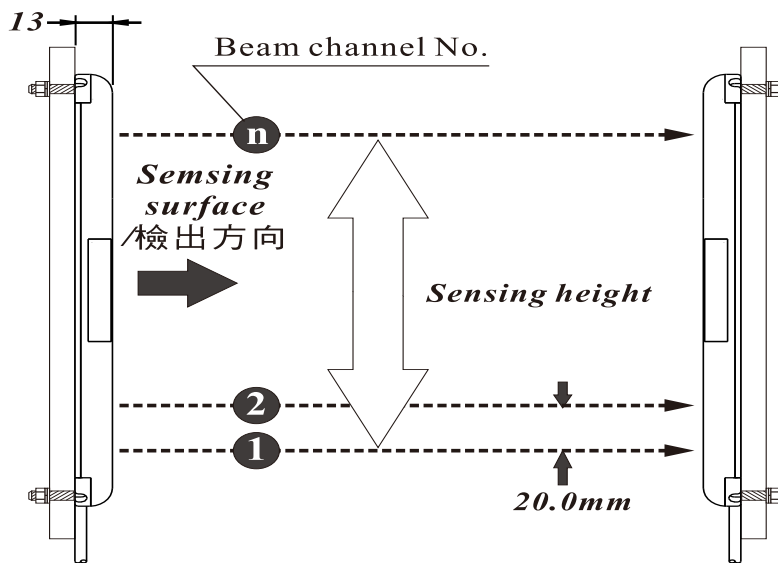

◆ Indicator / 指示燈 :

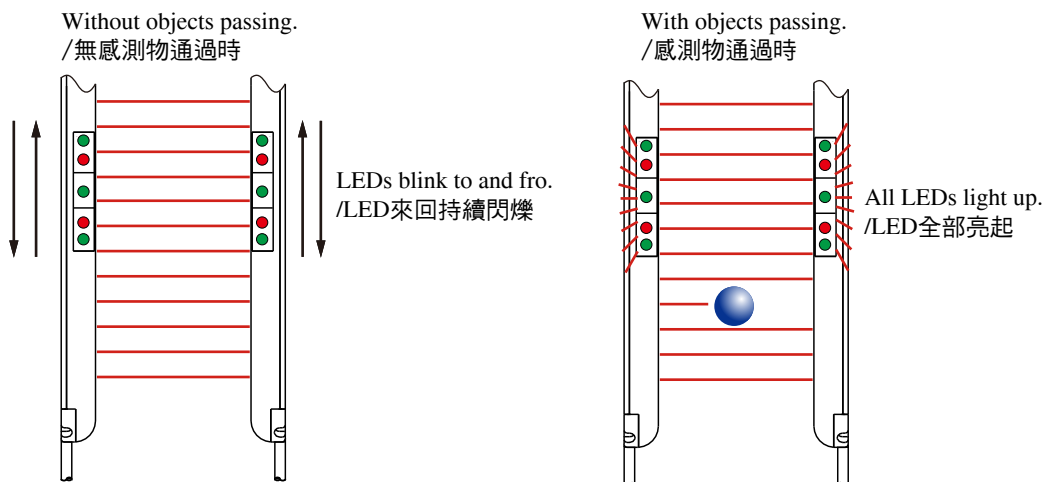

Model	Without objects passing.	With objects passing.
OAP-2008	5 LEDs blink to and fro (from top to bottom). (Green,Red,Green,Red,Green)	All 5 LEDs light up. (Green,Red,Green,Red,Green)
OAP-2016	7 LEDs blink to and fro (from top to bottom). (Green,Red,Green,Red,Green,Red,Green)	All 7 LEDs light up. (Green,Red,Green,Red,Green,Red,Green)

◆ I/O Circuit Diagram / 接線圖 :

Emitter(發射)

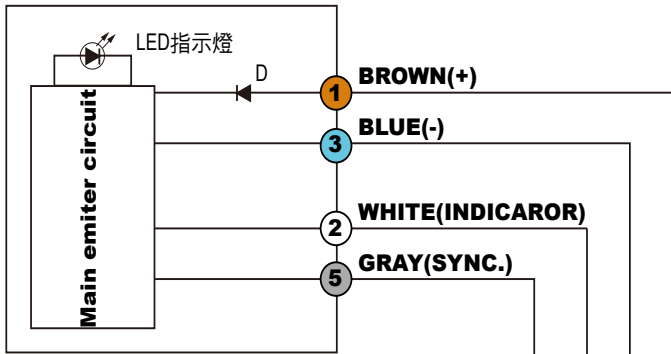

Receiver(接收)

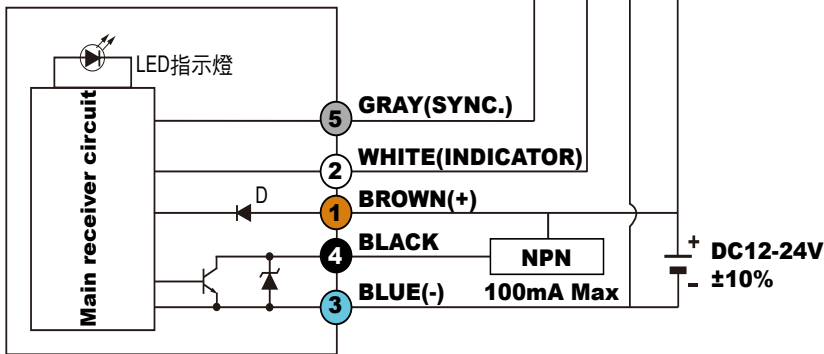

LOAD/ 負載
NPN open collector output.
Max current 100mA.
supplying voltage DC12~24V.

NPN最開放集極電路
最大輸出電流100mA
供應電壓DC12~24V

◆ Engineering data / 工程數據 :

OAP-2008-□ Angular deviation

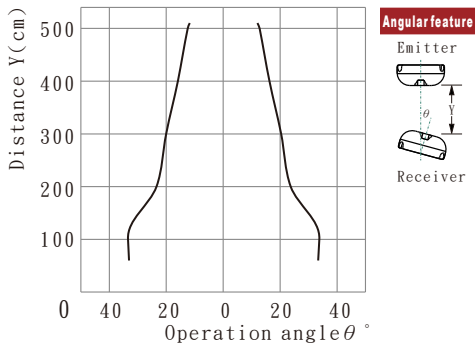

OAP-2016-□ Angular deviation

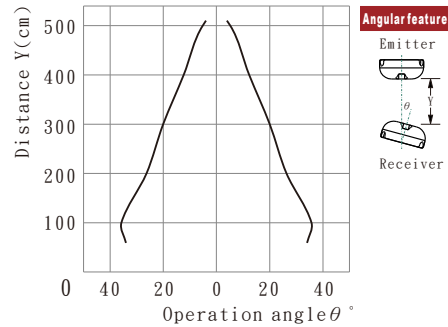

OAP-2008S-□ Angular deviation

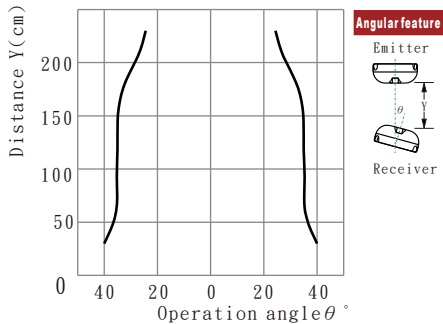

OAP-2016S- □ Angular deviation

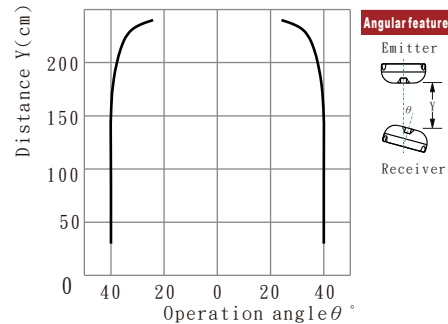

Photo Sensor

Area Sensor

Inductive Proximity Sensor

Capacitive Proximity Sensor

Timer / Counter

Others

Accessories

Photo Sensor

Area Sensor

Inductive Proximity Sensor

Capacitive Proximity Sensor

Timer / Counter

Others

Accessories

◆ Timer chart / 時序圖 :

• OAP-2008-□

Emitter

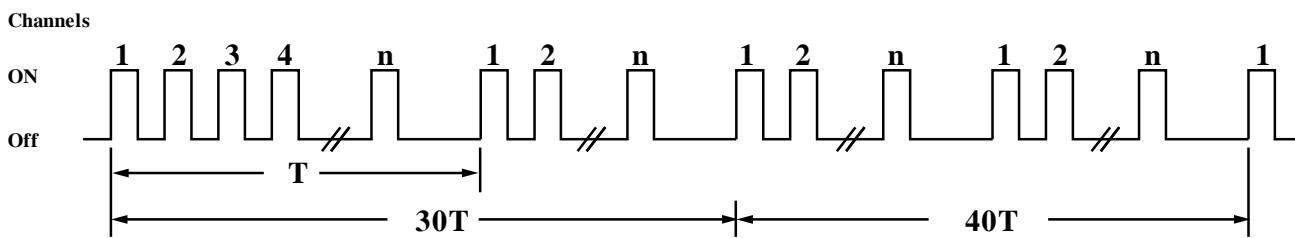

Receiver

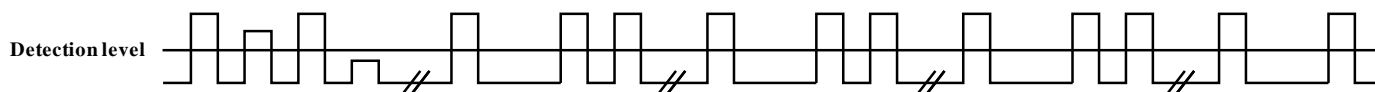

• OAP-2016-□

Emitter

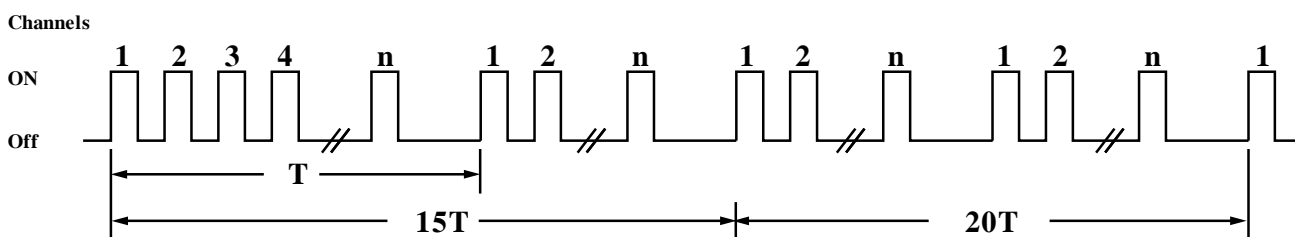

Receiver

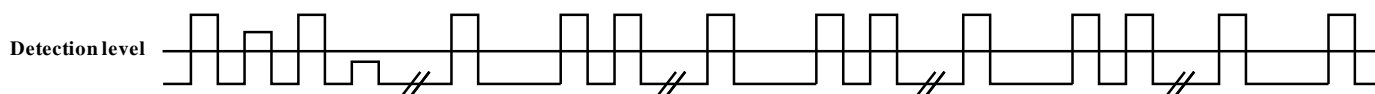

◆ Accessories / 選購配件：

• Connectors / 線材：

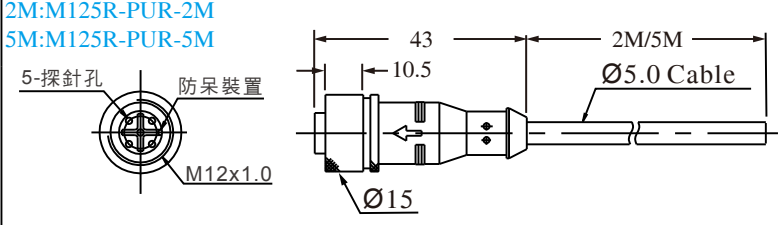
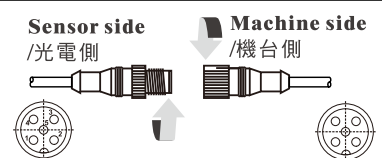
Dimensions / 尺寸圖	Material	Available Model/適用機種
<p>2M:M125R-PUR-2M 5M:M125R-PUR-5M</p> 	<p>1-BROWN 2-WHITE 3-BLUE 4-BLACK 5-GRAY</p>	<p>OAP-□K Series /OAP-□K系列機種</p> <p>Sensor side / 光電側 Machine side / 機台側</p> 

• OAP-Bracket / OAP固定架：

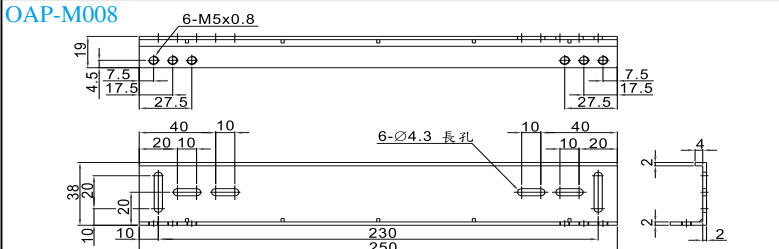
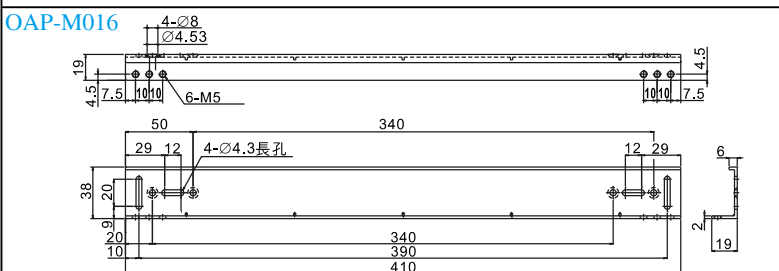
Dimensions / 尺寸圖	Material	Available Model/適用機種
<p>OAP-M008</p> 	Iron / 鐵板	<p>OAP-2008□ Series /OAP-2008□系列機種</p>
<p>OAP-M016</p> 		<p>OAP-2016□ Series /OAP-2016□系列機種</p>

• Mounting / 固定方式：

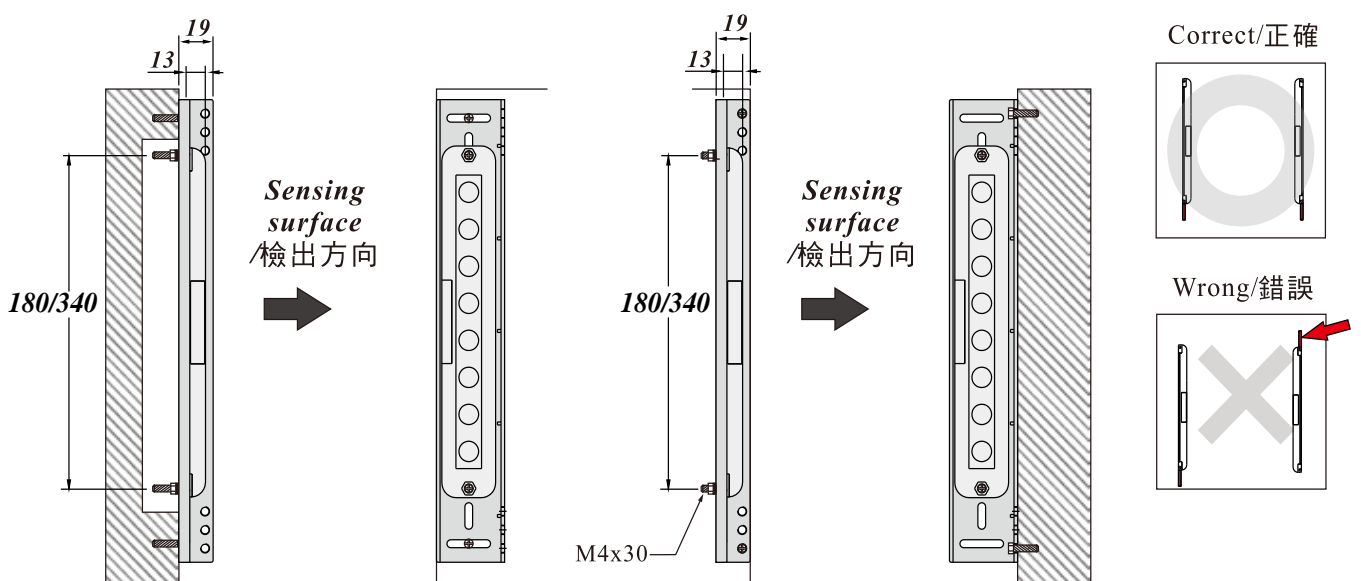

◆ATTENTION/注意事項：

⚠ Warning1 / 警告1

This product is not permitted to use with the machines which are not stopped electronically by electronic control. /不可使用於無立即停止電子控制式的機器。

⚠ Warning2 / 警告2

Be sure to set some amount of safe distance between the sensor and dangerous point.
/在感應器及危險區域間，必須保持安全距離。

- Safe distance (D) formula. Min distance is 150mm.
/安全距離(D)公式。最短距離150mm。

$$D=2000 \times T + \alpha \quad (D \leq 500\text{mm})$$

$$D=1600 \times T + \alpha \quad (D > 500\text{mm})$$

$$D = \text{safe distance (mm)}$$

$$T = \text{response time (machine+sensor)}$$

$$\text{反應時間} = (\text{機器的反應時間} + \text{感應器的反應時間})$$

$$\alpha = 90\text{mm}$$

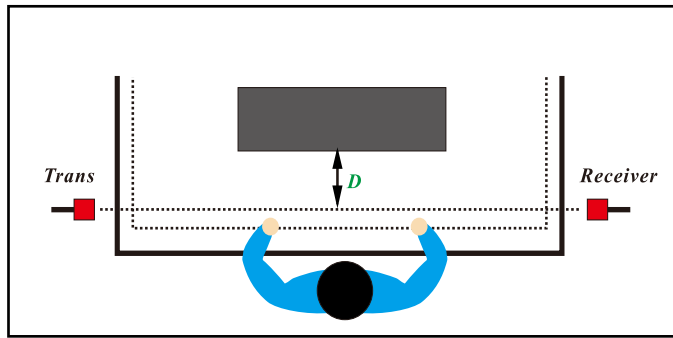

⚠ Warning3 / 警告3

Let work keep working through the detecting range.
/在感測範圍內進行工作。

◆Correct/正確

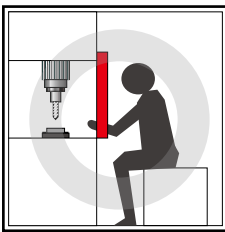

◆Wrong/錯誤

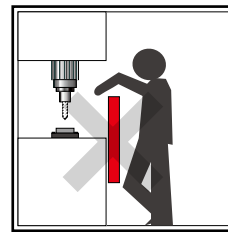
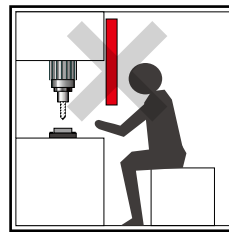

⚠ Warning4 / 警告4

When installing, please think of other reflecting object which may cause malfunction.
/安裝時，考慮是否有其它會導致機能故障的反射物。

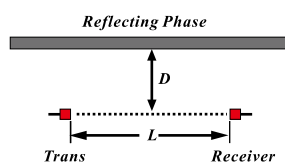
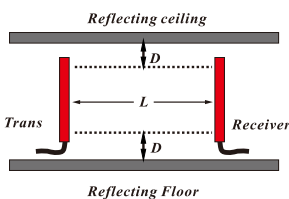

Acceptable installation distance

/可接受的安裝範圍

$$D \geq 150\text{mm}$$

$$L = 0.3 \sim 5\text{M}$$