



APPLIED MEASUREMENTS LTD.

Transducer Specialists...

+44 (0) 118 981 7339

info@appmeas.co.uk

<https://appmeas.co.uk>

DBBSM Series S-Beam Load Cell

Key Features:

- Capacities 0-1kg to 0-30,000kg
- Output: 2mV/V to 2.7mV/V
- High Accuracy: $<\pm 0.03\%/RC$
- Sealed to IP51
- Simple Installation
- Custom Versions Available
- High Performance
- High Side Load Resistance
- Robust Construction
- 3 Year Warranty



For use in Tension and Compression for Force and Load Measurement

The [DBBSM series of S-Beam load cells](#) are designed for use in tension and compression and lend themselves to both force measurement and weighing applications alike. Typical applications include tensile testing machines, suspended hoppers, geotechnical test equipment and other general purpose applications. Their ease of mounting makes them very attractive for use as a general purpose load cell.

A dual bending beam sensing design is used on all capacities up to 1000kg and a shear web sensing design is used from 2500kg upwards. Versions are also available in lbf and N (kN) ranges. Both the dual bending beam and the shear web design offer high accuracy performance of better than $\pm 0.03\%$ of the rated capacity.

The DBBSM series is sealed to IP51 as standard but can be enhanced to IP67 (50kg capacity and higher only) for more arduous applications.

If you need to fit into a restricted space try our [DBBSMM range of miniature S-Beam load cells](#) designed to fit where space is limited.

Options:

- Other Ranges Available
- Equivalents to Other Manufacturers
- Rod End Bearings & Load Buttons
- Internal Shunt Calibration Facility
- Improved Environmental Sealing to IP67 (50kg capacity and higher only)
- TEDS (Transducer Electronic Data Sheet)
- TEDS Allows Plug & Play with TEDS Enabled Instrumentation.
- USB Version (via DSC-USB)
- High Temperature Versions
- Vacuum Application Versions
- Single or Multi-Channel PC-Based Monitoring & Data Logging System
- Fatigue Rated - Available all Capacities
- Mounting Options
- Rationalised/Standardised Outputs
- Wireless Version (via T24 instrumentation)

Applications:

- Force & Load Measurement Applications
- Suspended Hoppers
- Geotechnical Test Equipment
- Tensile Testing Machines
- Wave Tank Monitoring (IP67 versions 50kg capacity and higher only)



APPLIED MEASUREMENTS LTD.

Transducer Specialists...

+44 (0) 118 981 7339





info@appmeas.co.uk

<https://appmeas.co.uk>

Specification:

	UNITS	DBBSM
Rated Capacity (RC)	kgf	0-1, 0-2, 0-5, 0-10, 0-25, 0-50, 0-100, 0-250, 0-500, 0-1000, 0-2500, 0-5000, 0-10000, 0-20000, 0-30000
Operating Modes	Tension/Compression / Tension & Compression	
Sensitivity (RO)	mV/V	2.7 nominal (2.0 nominal on 10000kgf>)
Zero Balance/Offset	±%/Rated Output	<1.0
Zero Return after 30 mins	±%/Applied Load	<0.03
Output Symmetry (tension vs. compression)	±%/Rated Output	0.1 to 0.25 typical
Non-Linearity	±%/Rated Output	<0.03
Hysteresis	% / Rated Output	<0.03
Repeatability	±%/Rated Output	<0.02
Temperature Effect on Zero	±%/Rated Output/°C	<0.005
Temperature Effect on Sensitivity	±%/Applied Load/°C	<0.005
Input Resistance	Ohms	375
Output Resistance	Ohms	350
Insulation Resistance	Megohms	>5000 @ 50Vdc
Excitation Voltage	Volts AC or DC	10 recommended (2-15 acceptable)
Operating Temperature Range	°C	-20 to +80
Compensated Temperature Range	°C	0 to +70
Storage Temperature Range	°C	-20 to +80
Safe Overload	% of Rated Capacity	150
Ultimate Overload	% of Rated Capacity	200
Maximum Safe Side Load	% of Rated Capacity	30
Deflection @ Rated Capacity	mm	see dimensional table
Fundamental Resonant Frequency*	Hz	see dimensional table
IP Rating (Environmental Protection)		IP51 (IP67 optional 50kg capacity and higher only)
Weight (excluding cable)	kg	see dimensional table
Fatigue Life		10 ⁸ cycles typical (10 ⁹ cycles on fatigue-rated version)
Cable Length (as standard)	metres	3
Cable Type		4-core screened, PUR sheath, Ø5
Construction Material		1kg-100kg: Aluminium Alloy / 250kg-30,000kg: Stainless Steel
Resolution		1 part in 250,000 (with appropriate instrumentation)
*The resonant frequency is calculated with the body of the load cell attached to a large plate, ensuring that only the sensing element oscillates: This is vital to achieve the highest natural frequency and subsequent frequency response.		

Wiring Diagram:

Wire	Designation
 Red	+ve excitation
 Blue	-ve excitation
 Green	+ve signal (tension)
 Yellow	-ve signal
 Screen	To ground - not connected to load cell body



Dimensions (mm):

Capacity (kgf)	H	L	W	WI	G	GI	Threads T	Deflection mm	Weight kg	Resonant Frequency Hz
0-1, 0-2, 0-5, 0-10, 0-25	60	48	12.7	20	30	6.35	M8 x 1.25	0.55; 0.58; 0.51; 0.41; 0.36	0.085	94; 130; 212; 326; 536
0-50, 0-100, 0-250	70	48	18	25	35	9	M8 x 1.25	0.41	0.14; 0.14; 0.33	530; 740; 715
0-500, 0-1000	75	48	30	37	37.5	15	M12 x 1.75	0.41; 0.56	0.56; 0.58	760; 900
0-2500, 0-5000	90	63	38	38	45	8	M16 x 2.0	0.33; 0.43	1.33; 1.35	1200; 1700
0-10,000	145	138	55	N/A	72.5	27.5	M30 x 2.0	0.16	6	1600
0-20000, 0-30000	190	190	75	N/A	95	37.5	M45 x 3.0	0.16; 0.16	25; 25	1100; 1400

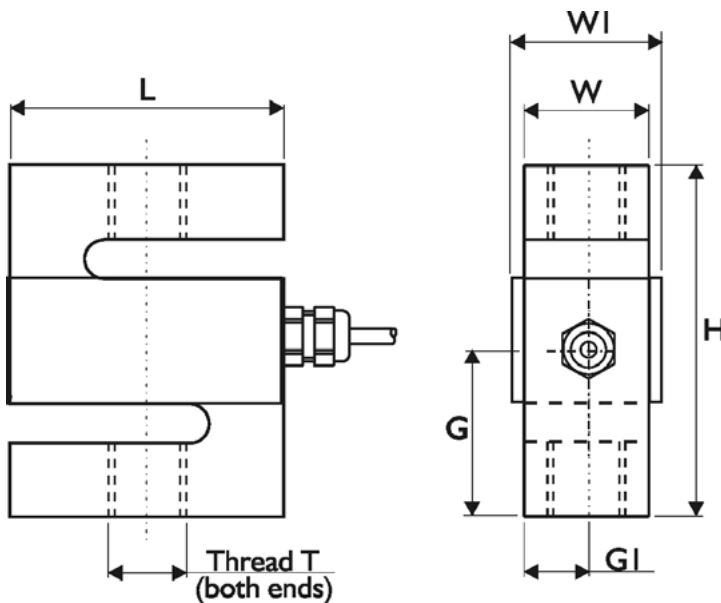

Note: On capacities over 10,000kg, cells will have rounded shoulders.

Ordering Codes:

Core Product	Capacity (inc Engineering Units)	Cable Length (m)	Specials Code	Example Result
DBBSM	1kg	003	000	DBBSM-1kg-003-000
DBBSM	2kg	003	000	DBBSM-2kg-003-000
DBBSM	5kg	003	000	DBBSM-5kg-003-000
DBBSM	10kg	003	000	DBBSM-10kg-003-000
DBBSM	25kg	003	000	DBBSM-25kg-003-000
DBBSM	50kg	003	000	DBBSM-50kg-003-000
DBBSM	100kg	003	000	DBBSM-100kg-003-000
DBBSM	250kg	003	000	DBBSM-250kg-003-000
DBBSM	500kg	003	000	DBBSM-500kg-003-000
DBBSM	1000kg	003	000	DBBSM-1000kg-003-000
DBBSM	2500kg	003	000	DBBSM-2500kg-003-000
DBBSM	5000kg	003	000	DBBSM-5000kg-003-000
DBBSM	10,000kg	003	000	DBBSM-10,000kg-003-000
DBBSM	20,000kg	003	000	DBBSM-20,000kg-003-000
DBBSM	30,000kg	003	000	DBBSM-30,000kg-003-000



APPLIED MEASUREMENTS LTD.
Transducer Specialists...

+44 (0) 118 981 7339

info@appmeas.co.uk

<https://appmeas.co.uk>

Associated Products:



[TR150 Handheld Indicator](#)



[T24 Wireless Telemetry Range](#)



[Intuitive4-L Panel-Mount Indicator](#)



[DSC-USB USB Signal Digitiser](#)

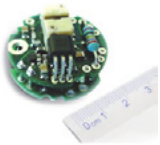

[ICA Miniature Strain Gauge Amplifier](#)



[SGA Signal Conditioner/Amplifier](#)

Associated Case Studies:

[Accurate S-Beam Load Cell Measures Cable Tension Of Light Aircraft](#)



In light aircraft the flight control system must have correctly adjusted cables to maintain correct rudder movement, smooth direction and precise level and control of flight. Calmet Laboratory Services used a DBBSM-1000kg s-beam load cell to check the accuracy of the aircraft tension meters when applying tension to a cable. [Read more...](#)

[Complete Tensile Monitoring System Delivered in Under 1 Week](#)

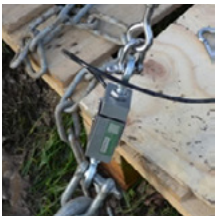

With huge capacities of up to 30,000kg and an accuracy of $<\pm 0.03\%$ of the rated capacity, the highly accurate DBBSM S-beam load cell really is the knight in stainless steel armour. Not only can it efficiently handle the larger loads in the guys, it can also be supplied in less than 1 week! Its tough construction makes it ideal to use in the harsh outdoor conditions on the guy cables. [Read more...](#)

[Force Measurement Determines The Effect of Girth Tension on Horse Gait](#)

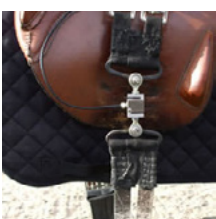

Using electrical systems for the measurement of mechanical forces is by no means limited to machines and laboratory based applications. In her recently completed research thesis 'Girth Tensions and their Effects on Equine Stride Characteristics', Sue Wright of Moulton College Northampton used load cells, motion sensors and GPS amongst other technologies to measure and record the tension within the girth strap used to hold the saddle in place. [Read more...](#)



Mounting and Installation Accessories:

Helping You Get The Best Possible Performance From Your Load Cell.

Load Buttons and Rod End Bearings

Designed to align forces through the principle axis of the load cell thus reducing the effects of extraneous forces, hence offering improved performance from the cell.

- Load buttons are used where compressive forces are applied.
- Rod End Bearings are used where tensile forces are being applied.

Load Buttons for Compression Use

Dimensions in mm:

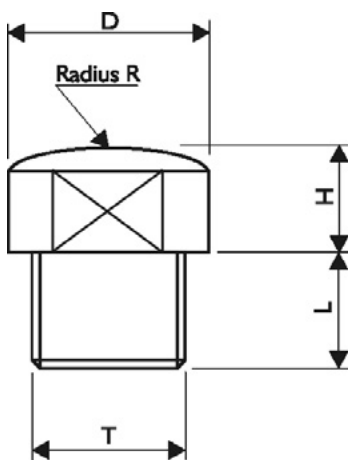

THREAD T	M8 x 1.25	M12 x 1.75	M16 x 2	M24 x 2	M30 x 2	M45 x 3
D	15	22	32	26	50	70
H	5	6	10	14	20	40
L	10	12	16	26	40	60
R	150	150	180	200	200	300

Rod End Bearings for Tension Use

Key Features:

- Supports radial loads in a tensile or compressive direction.
- Suitable for unilateral loads - can support alternating loads and alternating loads in combination with bearing GE..UK-2RS.
- Zinc plated for corrosion resistance.
- Are maintenance-free (in bearings with Elgoglide®, lubricant leads to a considerable reduction in bearing life)
- Fitted with radial spherical plain bearings GE..UK or GE..UK-2RS
- Hard chromium/PTFE composite or hard chromium/Elgoglide® sliding contact surfaces.
- Enables compact adjacent construction thanks to its thin walled design of the eye housing.



GAR..UK
(right hand thread)

GAR..UK-2RS
(right hand thread)

- To ISO 12 240-4, dimension series E, type M
- Shank with external thread
- Suffix -2RS: lip seals on both sides, for operating temperatures from -30°C to +130°C
- GAR..UK and GAL..UK for shaft diameters from 6mm to 30mm
- GAR..UK-2RS and GAL..UK-2RS for shaft diameters from 35mm to 80mm

Maintenance-free
ISO 12 240-4, dimension series E, type M
Sliding contact surface: hard chromium/PTFE

Series GAR..UK
Sliding material: PTFE composite

GAR..UK-2RS
Sliding material: Elgoglide®



APPLIED MEASUREMENTS LTD.

Transducer Specialists...

+44 (0) 118 981 7339

info@appmeas.co.uk

<https://appmeas.co.uk>

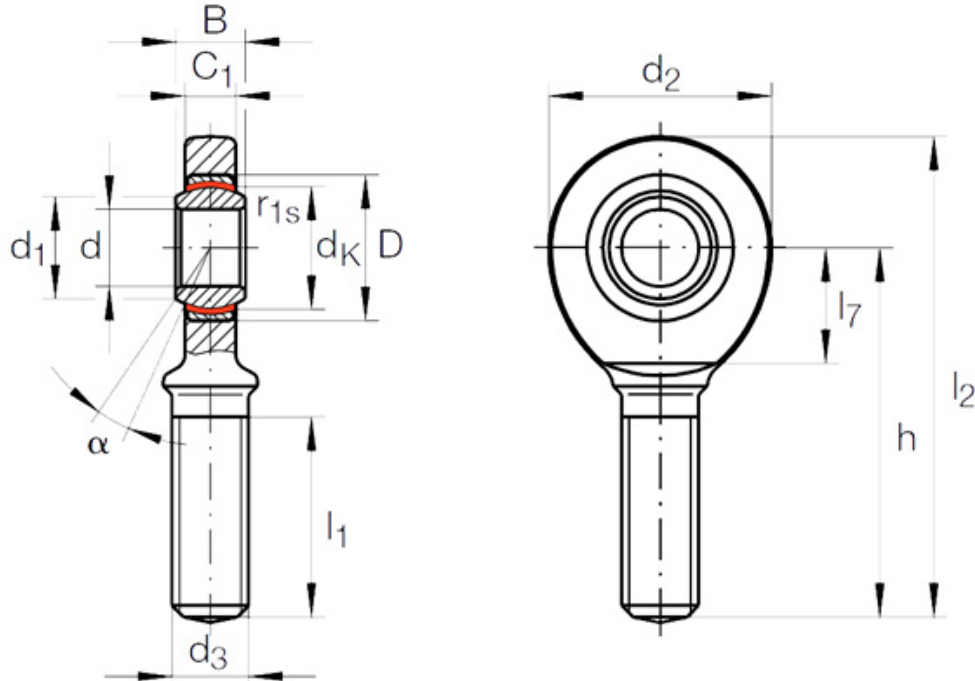

LOAD CELL	SHAFT DIAMETER	ORDERING CODE		MASS ≈ kg	DIMENSIONS						
		WITHOUT SEALS	WITH SEALS		d	D	B	dk	d ₁	d ₂	d ₃
DBBSM-5kg to 250kg	8	GAR 8 UK	-	0.029	8 _{-0.008}	16	8 _{-0.12}	13	10.2	24	M8
DBBSM-500kg to 1000kg	12	GAR 12 UK	-	0.086	12 _{-0.008}	22	10 _{-0.12}	18	14.9	34	M12
DBBSM-2500kg to 5000kg	17	GAR 17 UK	-	0.19	17 _{-0.008}	30	14 _{-0.12}	25	20.7	46	M16
DBBSM-10,000kg	30	GAR 30 UK	-	0.89	30 _{-0.01}	47	22 _{-0.12}	40.7	34.2	73	M30x2
DBBSM-20,000kg to 30,000kg	50	-	GAR 50 UK-2RS	3.4	50 _{-0.012}	75	35 _{-0.12}	66	55.9	112	M45 x 3

TYPE	h	C ₁	Degrees			Chamfer Dimension	Basic Load Ratings ¹⁾		Radial Internal Clearance	Shaft Diameter	
			α	l ₁	l ₂		l ₇	r1s min.			dyn. Cr N
DBBSM-5kg to 250kg	42	6	15	22	54	14	0.3	5 850	12 900	0 - 0.032	8
DBBSM-500kg to 1000kg	54	8	11	28	71	18	0.3	11 400	30 100	0 - 0.032	12
DBBSM-2500kg to 5000kg	69	11	10	36	92	23	0.3	22 400	56 500	0 - 0.04	17
DBBSM-10,000kg	110	19	6	65	146.5	37	0.6	65 500	138 000	0 - 0.05	30
DBBSM-20,000kg to 30,000kg	185	30	6	107	241	60	0.6	442 000	313 000	0 - 0.06	50

1) Basic load rating of housing.

In rod ends with the sliding material Elgoglide®, the basic load rating C_{0r} of the housing is less than the basic dynamic load rating C_r of the bearing.